

TravelMate 2200/2700 Series

User's Guide

Copyright © 2004
All Rights Reserved

TravelMate 2200/2700 Series Notebook Computer User's Guide
Original Issue: August 2004

Changes may be made periodically to the information in this publication without obligation to notify any person of such revision or changes. Such changes will be incorporated in new editions of this manual or supplementary documents and publications. This company makes no representations or warranties, either expressed or implied, with respect to the contents hereof and specifically disclaims the implied warranties of merchantability or fitness for a particular purpose.

Record the model number, serial number, purchase date, and place of purchase information in the space provided below. The serial number and model number are recorded on the label affixed to your computer. All correspondence concerning your unit should include the serial number, model number, and purchase information.

No part of this publication may be reproduced, stored in a retrieval system, or transmitted, in any form or by any means, electronic, mechanical, photocopy, recording, or otherwise, without the prior written permission of Acer Incorporated.

TravelMate 2200/2700 Series Notebook Computer

Model Number : _____

Serial Number: _____

Purchase Date: _____

Place of Purchase: _____

All trademarks and registered trademarks are the properties of their respective companies.

First things first

Your guides

A set of guides is provided to help you set up and use your TravelMate, Aspire computer:



The ***Just for starters...*** poster shows you how to set up your computer.



This ***User's Guide*** provides clear and concise information on using your computer productively. You are advised to read it thoroughly and keep it handy for future reference.

For more information on Acer's products, services, and support, please visit the web site: <http://www.acer.com>.

Basic care and tips for using your computer

Turning your computer on and off

To turn on your computer, open the lid and press the power button above the keyboard.

To turn the power off, you can do any of the following:

- Click on the **Start** button in Windows, and then select **Shut Down** on the popup menu.
- Push the power button.

To use this method, you must first click on the **Power Management** icon in Windows **Control Panel**, and then check that the power button is set to shut down the computer when pressed. See

Windows **Help and Support** for more information.



Note: If you are unable to shut down the computer in the usual way, press and hold the power button for more than four seconds. You should then wait at least two seconds before turning the computer on again.

Taking care of your computer

Your computer will serve you well if you take care of it.

- Do not expose the computer to direct sunlight. Do not place it near sources of heat, such as a radiator.
- Do not expose the computer to temperatures below 0°C (32°F), or above 50°C (122°F).
- Do not expose the computer to magnetic fields.
- Do not expose the computer to rain or moisture.
- Do not spill water or any liquid on the computer.
- Do not subject the computer to heavy shock or vibration.
- Do not expose the computer to dust or dirt.
- Do not place objects on top of the computer.
- Do not slam the lid shut. Close the computer gently.
- Do not place the computer on unstable or uneven surfaces.

Taking care of your AC adapter

It is important that you look after your AC adapter.

- Do not connect the adapter to any other device.
- Do not step on the power cord or place heavy objects on it. Route the power cord away from areas where people might walk on it or trip over it.
- Do not pull on the power cord when disconnecting from the mains power socket. Grasp and pull the plug instead.
- The total ampere ratings of equipment plugged into a power strip should not exceed the ampere rating for that power strip.

Taking care of your battery pack

It is also important that you look after your computer's battery pack.

- Use the correct battery model for your computer. Do not use other kinds of batteries.
- Turn the power off before removing or replacing the battery.
- Do not tamper with the battery. Keep the battery away from children.
- Dispose of batteries according to local regulations. Recycle if possible.

Cleaning and servicing

When cleaning your computer, it is important that you follow these steps:

- Turn off the computer and remove the battery.
- Disconnect the AC adapter.
- Clean with a soft cloth moistened with a little water. Do not use liquid or aerosol cleaners.

Refer to the chapter entitled "Frequently asked questions" on page 67 if any of the following occurs:

- You drop the computer or damage the case.
- You spill liquid on the computer.
- The computer does not operate normally.

First things first	iii
Your guides	iii
Basic care and tips for using your computer	iii
Getting familiar with your computer	1
A tour of your computer	3
Front view	3
Front view	5
Left view	6
Right view	7
Rear view	8
Bottom view	9
Features	10
Indicators	12
Using the keyboard	13
Lock keys	13
Embedded numeric keypad	14
Windows keys	15
Hot keys	16
Special Key	18
Touchpad	19
Touchpad basics	19
Launch keys	21
Storage	23
Ejecting the optical drive tray	23
Emergency ejection of the optical drive tray	24
Connectivity options	25
Ethernet and LAN	25
Fax/Data modem	26
Fast infrared	27
Audio	28
Securing your computer	29
Security slot	29
Operating on battery power	31
Battery pack	33
Battery pack characteristics	33
Installing and removing the battery pack	34
Charging the battery	35
Checking the battery level	35
Optimizing battery life	35
Battery-low warning	36
Power management	37

Content

Peripherals and options	39
External display devices	41
External input devices	41
External keyboard	41
External keypad	41
External pointing device	41
USB devices	42
Printer	43
Audio devices	43
Expansion devices	44
PC Card	44
	45
Miscellaneous options	45
Battery pack	45
AC adapter	45
Key component upgrades	46
Memory upgrade	46
Hard disk upgrade	47
Moving with your computer	49
Disconnecting from the desktop	51
Moving around	52
Preparing the computer	52
What to bring to short meetings	52
What to bring to long meetings	52
Taking the computer home	53
Preparing the computer	53
What to bring with you	53
Special considerations	53
Setting up a home office	54
Traveling with the computer	54
Preparing the computer	54
What to take with you	54
Special considerations	54
Traveling internationally with your computer	55
Preparing the computer	55
What to take with you	55
Special considerations	55
Software	57
System software	59
Using system utilities	60
Acer eManager	60

Launch Manager	61
BIOS Utility	61
Acer Disc to Disc Recovery	62
Multilingual operating system installation	62
Restore without a Recovery CD	62
Setup password and exit	63
Troubleshooting	65
Frequently asked questions	67
Requesting service	70
International Traveler's Warranty (ITW)	70
Before you call	70
Appendix A Specifications	71
Appendix B	
Regulation & safety notices	77
Index	93

Getting familiar with
your
computer

Your TravelMate computer combines solid performance, versatility, multimedia capabilities and portability with a stylish design. Increase your productivity by working wherever you are.

This chapter provides an in-depth "tour" of your computer's features.

A tour of your computer

After setting up your new TravelMate, Aspire notebook computer, as illustrated in the *Just for starters...* poster, take a few minutes to explore the unit.

Front view







#	Item	Description
1	Display screen	Also called Liquid-Crystal Display (LCD), displays computer output.
2	Launch Keys	Buttons for launching frequently used programs. See "Launch keys" on page 21 for more details.

#	Item	Description
3	Status indicators	Light-Emitting Diodes (LEDs) that turn on and off to show the status of the computer, its functions and components.
4	Power button	Turns on the computer power.
5	Keyboard	Inputs data into your computer.
6	Touchpad	Touch-sensitive pointing device which functions like a computer mouse.
7	Palmrest	Comfortable support area for your hands when you use the computer.
8	Click buttons (left, center and right)	The left and right buttons function like the left and right mouse buttons; the center button serves as a 4-way scroll button.



Front view



#	Item	Description
1	Speakers	Left and right speakers deliver stereo audio output.
2	Power indicator 	Lights green when the computer is on and lights orange when the computer is in suspend mode.
3	Battery indicator 	Lights orange when the battery is being charged and lights green when the battery is full charged.
4	Bluetooth communications 	Lights to indicate the status of Bluetooth (optional) communications.
5	Wireless communications 	Lights to indicate the status of wireless LAN (optional) communications.
6	Latch	Locks and releases the lid.





Left view

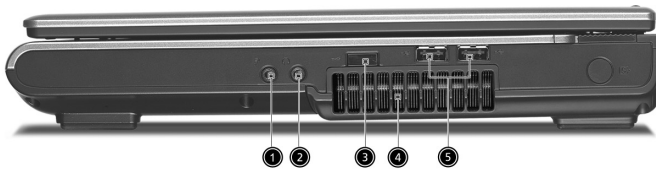

#	Item	Description
1	Security keylock 	Connects to a Kensington-compatible computer security lock.
2	Two USB 2.0 ports 	Connect to Universal Serial Bus (USB) 2.0 devices (e.g., USB mouse and USB camera).
3	PC Card slots 	Support one Type II CardBus PC Card.
4	Eject button	Ejects the PC Card(s) from the slot.
5	Optical drive	Internal optical drive; accepts CDs or DVDs depending on the optical drive type.
6	LED indicator	Lights up when the optical drive is active.
7	Eject button	Ejects the optical drive tray from the drive.
8	Emergency eject slot	Ejects the optical drive tray when the computer is turned off. See page 24 for more details.





Right view



#	Item	Description
1	Line-in/Mic-in jack 	Accepts audio line-in devices (e.g., audio CD player and stereo walkman).
2	Speaker/Line-Out/Headphone jack 	Connects to audio line-out devices (e.g., speakers and headphones).
3	Infrared port 	Interfaces with infrared devices (e.g., infrared printer and IR-aware computer).
4	Ventilation slots	Enable the computer to stay cool, even after prolonged use.
5	Two USB 2.0 ports 	Connect to Universal Serial Bus (USB) 2.0 devices (e.g., USB mouse and USB camera).

Rear view



#	Item	Description
1	Power jack 	Connects to an AC adapter.
2	Ventilation slots	Enable the computer to stay cool, even after prolonged use.
3	External display port 	Connects to a display device (e.g., external VGA monitor and LCD projector).
4	Modem jack 	Connects to a phone line.
5	Network jack 	Connects to an Ethernet LAN network.

Bottom view

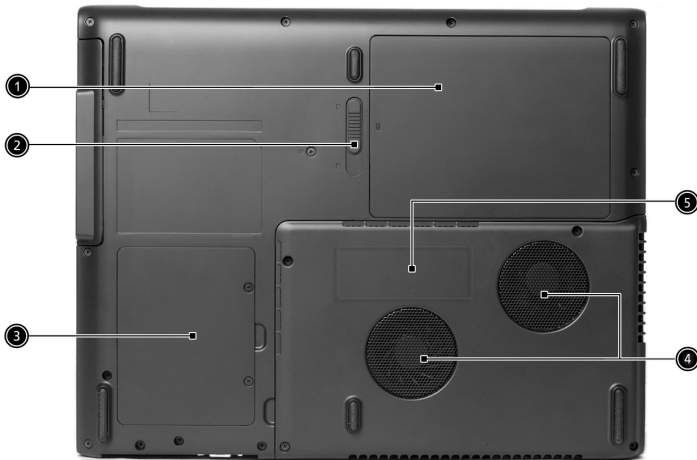

#	Item	Description
1	Battery bay	Houses the computer's battery pack.
2	Battery release latch	Unlatches to remove the battery pack.
3	Hard disk bay	Houses the computer's hard disk.
4	Cooling fans	Help keep the computer cool. Note: Don't cover or obstruct the opening of the fans.
5	Memory compartment	Houses the computer's main memory.

Features

Performance

- Intel® Pentium® 4 processors 2.8/3.0/3.2/3.4/3.6 GHz or Intel® Celeron® processors 2.6 GHz and above
- ATI MOBILITY™ RADEON™ 9000 IGP chipset
- 256/512 MB of DDR333 SDRAM, upgradeable to 2048 MB with dual soDIMM modules
- 30 GB and above high-capacity, Enhanced-IDE hard disk
- Advanced Configuration Power Interface (ACPI) power management system

Display

- The TFT LCD panel providing a large viewing area for maximum efficiency and ease-of-use:
 - 15.0" XGA (1024x768) resolution
 - 15.4" WXGA (1280x800) resolution
- 3D graphics support
- Simultaneous LCD and CRT display support
- "Automatic LCD dim" feature, automatically selecting the best setting for the display in order to conserve power
- DualView™ support

Multimedia

- High-speed built-in optical drive: DVD/CD-RW Combo, DVD-Dual, or DVD-Super Multi
- MS DirectSound compatible
- Built-in dual speakers

Connectivity

- Integrated 10/100 Mbps Fast Ethernet connection
- Built-in 56Kbps fax/data modem
- Four Universal Serial Bus (USB) 2.0 ports
- Fast infrared wireless communication (manufacturing option)
- IEEE 802.11b/g Wireless LAN (manufacturing option)
- Bluetooth® (manufacturing option)

Human-centric design

- Rugged, yet extremely portable design
- Stylish appearance
- Full-size keyboard with four programmable launch keys
- Comfortable palm rest area with well-positioned touchpad



Expansion

- One Type II CardBus PC Card slot
- Upgradeable memory modules

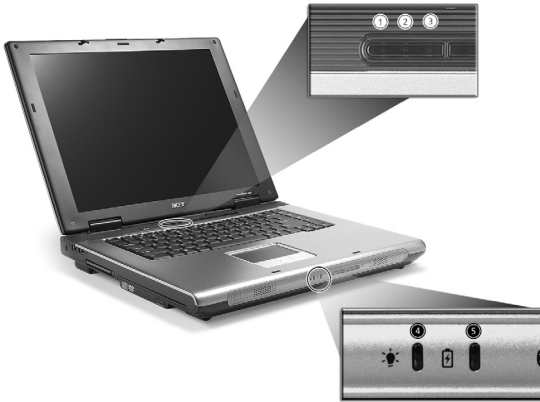

Indicators

The computer has three easy-to-read status icons below the display screen.



#	Icon	Function	Description
1		Caps Lock	Lights when Caps Lock is activated.
2		Num Lock	Lights when Num Lock is activated.
3		Media activity	Lights when the hard disk or optical drive is active.

In addition, there are two indicators at the front panel. Even when the cover is closed, the state or features can still be seen.

#	Icon	Function	Description
4		Power	Lights green when the computer is on and lights orange when in suspend mode.
5		Battery indicator	Lights orange when the battery is being charged and green when the battery is fully charged.

Using the keyboard

The keyboard has full-sized keys and an embedded keypad, separate cursor keys, two Windows keys and twelve function keys.

Lock keys

The keyboard has three lock keys which you can toggle on and off.

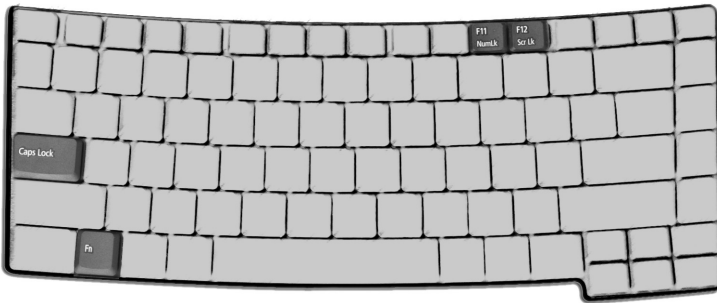

Lock Key	Description
Caps Lock	When Caps Lock is on, all alphabetic characters typed are in uppercase.
Num Lock (Fn-F11)	When Num Lock is on, the embedded keypad is in numeric mode. The keys function as a calculator (complete with the arithmetic operators +, -, *, and /). Use this mode when you need to do a lot of numeric data entry. A better solution would be to connect an external keypad.
Scroll Lock (Fn-F12)	When Scroll Lock is on, the screen moves one line up or down when you press the up or down arrow keys respectively. Scroll Lock does not work with some applications.

Embedded numeric keypad

The embedded numeric keypad functions like a desktop numeric keypad. It is indicated by small characters located on the upper right corner of the keycaps. To simplify the keyboard legend, cursor-control key symbols are not printed on the keys.









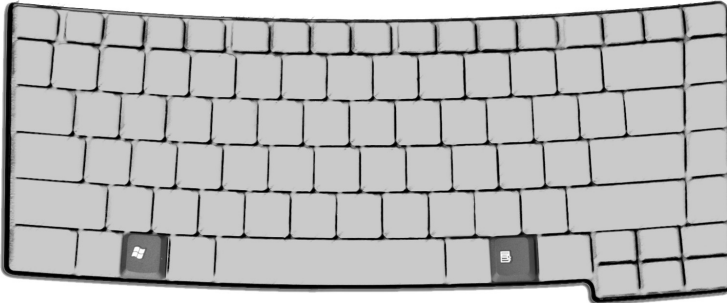



Desired Access	Num Lock On	Num Lock Off
Number keys on embedded keypad	Type numbers in a normal manner.	
Cursor-control keys on embedded keypad	Hold Shift while using cursor-control keys.	Hold Fn while using cursor-control keys.
Main keyboard keys	Hold Fn while typing letters on embedded keypad.	Type the letters in a normal manner.

Windows keys

The keyboard has two keys that perform Windows-specific functions.





Key	Description
Windows key 	Pressed alone, this key has the same effect as clicking on the Windows Start button; it launches the Start menu. It can also be used with other keys to provide a variety of functions: <ul style="list-style-type: none">  + Tab Activates the next Taskbar button.  + E Opens the My Computer window.  + F1 Opens Help and Support.  + F Opens the Find: All Files dialog box.  + M Minimizes all windows. Shift +  + M Undoes the minimize all windows ( + M) action.  + R Opens the Run dialog box.
Application key 	This key has the same effect as clicking the right mouse button; it opens the application's context menu.











Hot keys

The computer employs hot keys or key combinations to access most of the computer's controls like screen brightness, volume output and the BIOS Utility.

To activate hot keys, press and hold the **Fn** key before pressing the other key in the hot key combination.



Hot Key	Icon	Function	Description
Fn-F1	?	Hot key help	Displays help on hot keys.
Fn-F2		Acer eSetting	Launches the Acer eSetting in the Acer eManager set by the Acer Empowering Key. See "Acer eManager" on page 60.
Fn-F3		Power Management	Launches power options.
Fn-F4	Z ^Z	Sleep	Puts the computer in Sleep mode.

Hot Key	Icon	Function	Description
Fn-F5		Display toggle	Switches display output between the display screen, external monitor (if connected) and both the display screen and external monitor.
Fn-F6		Screen blank	Turns the display screen backlight off to save power. Press any key to return.
Fn-F7		Touchpad toggle	Turns the internal touchpad on and off.
Fn-F8		Speaker toggle	Turns the speakers on and off.
Fn-↑		Volume up	Increases the sound volume.
Fn-↓		Volume down	Decreases the sound volume.
Fn-→		Brightness up	Increases the screen brightness.
Fn-←		Brightness down	Decreases the screen brightness.
Alt Gr-\$		US dollar	Types the US dollar sign.
Alt Gr-Euro		Euro	Types the Euro symbol.

Special Key

You can locate the Euro symbol and US dollar sign at the upper-center and/or bottom-right of your keyboard. To type:

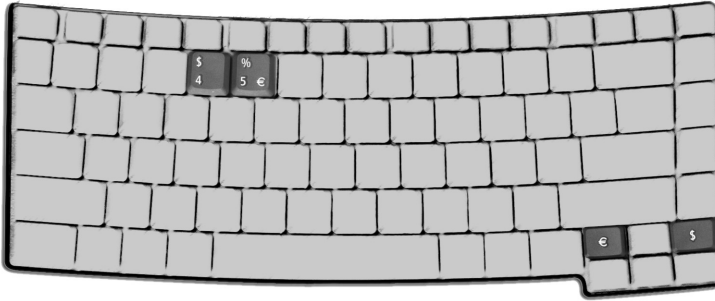

The Euro symbol

- 1 Open a text editor or word processor.
- 2 Either directly press the **Euro** symbol at the bottom-right of the keyboard, or hold **Alt Gr** and then press the **Euro** symbol at the upper-center of the keyboard.

The US dollar sign

- 1 Open a text editor or word processor.
- 2 Either directly press the **dollar** sign at the bottom-right of the keyboard, or hold **Alt Gr** and then press the **dollar** sign at the upper-center of the keyboard.



.....
Note: This function varies by the operating system version.

Touchpad

The built-in touchpad is a PS/2-compatible pointing device that senses movement on its surface. The cursor responds to your finger movements on the touchpad. In addition, the two click buttons provide the same functionality as a computer mouse, while the scroll key enables easy 4-way scrolling in documents and web pages.

The touchpad is located in the middle of the palm rest area, providing maximum comfort and efficiency.



Touchpad basics

Use the touchpad as follows:

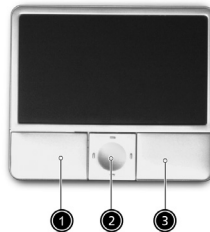

- Slide your finger over the surface of the touchpad to control the movement of the cursor. Tap the touchpad to perform selection and execution functions.
- Press the left **(1)** and right **(3)** click buttons to perform selection and execution functions, just as you would use the buttons on a computer mouse.
- Use the scroll key **(2)** to scroll through long documents and web pages. Press the top of the key to scroll up, bottom to scroll down; left to scroll left, and right to scroll right.

Function	Left Button	Right Button	4-Way Scroll Key	Tap
Execute	Click twice quickly.			Tap twice quickly.
Select	Click once.			Tap once.
Drag	Click and hold. Then, slide your finger across the touchpad to drag the cursor over the selection.			Tap twice quickly. On the second tap, slide your finger across the touchpad to drag the cursor over the selection.
Access content menu		Click once.		
Scroll			Click and hold the up/down/left/right button.	



Note: Keep your fingers, as well as the surface of the touchpad, clean and dry. The touchpad is sensitive to your finger movements: the lighter your touch, the better the response. Tapping hard will not increase the touchpad's responsiveness.

Launch keys



Located at the upper-right above the keyboard are four buttons. These buttons are called launch keys. They are designated as the mail, Web browser, Empowering and programmable keys.

Press the Acer Empowering Key to run the Acer eManager. Please see "Acer eManager" on page 60. The mail and Web browser are default for Email and Internet programs, but can be reset by users. To set the mail, Web browser and programmable keys, run the Acer Launch Manager. See "Launch Manager" on page 61.



#	Launch Key	Default Application
1	Email	Launches your email application.
2	Web browser	Launches your Internet browser.
3	e	Acer eManager application (User-programmable)
4	P	User-programmable.

In addition, there are two launch keys at the front panel. Even when the cover is closed, you can easily access the features of Wireless and Bluetooth®. However, the Wireless and Bluetooth keys cannot be reset by users.

#	Launch Key	Default Application
5	Bluetooth 	Enables your Bluetooth.(optional)
6	Wireless 	Enables your 802.11b/g Wireless LAN.(optional)



.....

Caution: It is important that the Bluetooth and Wireless LAN features are turned off before boarding an airplane.

Storage

Your computer offers a variety of data storage options:

- The high capacity Enhanced-IDE hard disk drive.
The hard drive is upgradeable, enabling you to increase your storage capacity in the future. Consult your dealer if you need to upgrade.
- The high speed optical drive.
Depending on your model, you have a DVD/CD-RW Combo, DVD-Dual, or DVD Super-Multi drive. The optical drive provides increased storage capacity, as well as offering a host of multimedia possibilities.

See the section entitled "A tour of your computer" on page 3 for the locations of these drives.

Ejecting the optical drive tray

To eject the optical drive tray:

- With the computer turned on, press the optical drive eject button.
- The tray will be released, and partially popped open.
- Gently pull the tray out to its limit.



To load an optical disc:

- Place a CD or DVD on the open tray. Align the disc's center hole with the tray's spindle.
- Gently push down on the disc until it clicks in place on the spindle.
- Gently push in the tray until it clicks closed.

Emergency ejection of the optical drive tray

If you need to eject the optical drive tray when the computer is turned off, push a straightened paper clip into the optical drive emergency eject hole. The tray will be released, and partially popped open.



Connectivity options

Your computer has built-in connectivity options, enabling you to hook up to a network or communicate over a phone line.

Ethernet and LAN

The integrated network feature allows you to connect your computer to an Ethernet-based (10/100 BASE-T) network.

To use the network feature, plug an Ethernet cable into your computer's network jack, and then connect the other end to a network jack or hub on your network.



See Windows Help and Support for information on setting up a network connection.

Fax/Data modem

Your computer features a built-in fax/data modem, enabling you to communicate over a phone line. This means that you can connect to the Internet via a dialup account with an ISP, log in to your network from a remote location, or send faxes.



.....
Warning: Your modem is not compatible with digital phone lines. Plugging the computer into a digital phone system will damage the modem.

To use the fax/data modem, plug a phone cable into your computer's modem jack, and then connect the other end to a telephone jack.



.....
Warning: Please use the delivered phone cable in the country of use.

Fast infrared

The computer's fast infrared (FIR) port allows you to do wireless data transfer with other IR-aware computers and peripherals such as PDAs (personal digital assistants), mobile phones, and infrared printers. The infrared port can transfer data at speeds of up to four megabits per second (Mbps) at a distance of up to one meter.



.....
Note: The Fast Infrared feature is available on certain models only.

Audio

Your computer includes an integrated stereo audio system. Built-in stereo speakers are located at the front of the unit.



Volume is adjusted using software, such as Volume Control in Windows, Volume **Fn** keys, or any other application that provides a volume adjustment control.

Two audio ports on the right side of the computer enable external devices to be connected. See "A tour of your computer" for the location of the audio ports. For information on connecting external devices, see "Audio devices" in the section entitled, "Peripherals and options."

Securing your computer

Your computer features hardware and software security solutions, in the form of a slot for a Kensington lock and a password facility.

Security slot

A slot for a Kensington slot enables you to physically protect your computer from theft. Use this feature as follows:

- Wrap a security lock cable around a heavy or immovable object, such as a drawer handle on a file cabinet, or a table leg.
- Insert the lock into the slot on the computer, turn it 90°, and then lock it in place.

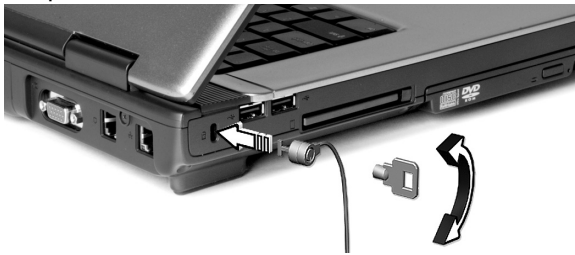

Setting a password

Passwords protect your computer from unauthorized access. When set, no one can access the computer without entering the correct password.

There are three types of passwords you can set:

- 1 Supervisor Password secures your computer against unauthorized entry to and use of the BIOS Utility.
- 2 User Password secures your computer against unauthorized use.
- 3 Hard Disk Password protects your data by preventing unauthorized access to your hard disk.



.....
Important! Do not forget your Setup and Hard Disk passwords! If you forget your passwords, please get in touch with your dealer or an authorized service center.

You can set the passwords using the BIOS Utility.

Operating on
battery power

Your TravelMate computer operates on battery or AC power.

This chapter provides information for operating on battery power, as well as information on how your computer manages and saves power.

Battery pack

The computer uses a battery pack that gives you long use between charges.

Battery pack characteristics

The battery pack has the following characteristics:

- Employs current battery technology standards.
- Delivers a battery-low warning.

The battery is recharged whenever you connect the computer to the mains power supply. Your computer supports charge-in-use, enabling you to recharge the battery while you continue to operate the computer. However, recharging with the computer turned off results in a significantly faster charge time.

The battery will come in handy when you travel or during a power failure. It is advisable to have an extra fully charged battery pack available as backup. Contact your dealer for details on ordering a spare battery pack.

Maximizing the battery's life

Like all other batteries, your computer's battery will degrade over time. This means that the battery's performance will diminish with time and use. To maximize your battery's life, you are advised to adhere to the recommendations set out below.

Conditioning a new battery pack

Before you use a battery pack for the first time, there is a "conditioning" process that you should follow:

- 1 Insert the new battery without turning the computer on.
- 2 Connect the AC adapter and fully charge the battery.
- 3 Disconnect the AC adapter.
- 4 Turn on the computer and operate using battery power.
- 5 Fully deplete the battery until the battery-low warning appears.

6 Reconnect the AC adapter and fully charge the battery again.

Follow these steps again until the battery has been charged and discharged three times.

Use this conditioning process for all new batteries, or if a battery hasn't been used for a long time. If the computer is to be stored for more than two weeks, you are advised to remove the battery pack from the unit.



Warning: Do not expose battery packs to temperatures below 0°C (32°F) or above 60°C (140°F). Extreme temperatures may adversely affect the battery pack.

By following the battery conditioning process you condition your battery to accept the maximum possible charge. Failure to follow this procedure will prevent you from obtaining the maximum battery charge, and will also shorten the effective lifespan of the battery.

In addition, the useful lifespan of the battery is adversely affected by the following usage patterns:

- Using the computer on constant AC power with the battery inserted. If you want to use constant AC power, you are advised to remove the battery pack after it is fully charged.
- Not discharging and recharging the battery to its extremes, as described above.
- Frequent use; the more you use the battery, the faster it will reach the end of its effective life. A standard computer battery has a life span of about 500 charges.

Installing and removing the battery pack



Important! Before removing the battery from the unit, connect the AC adapter if you want to continue using your computer. Otherwise, turn off the computer first.

To install a battery pack:

- 1 Align the battery with the open battery bay; make sure that the end with the contacts will enter first, and that the top surface of the battery is facing up.

- 2 Slide the battery into the battery bay and gently push until the battery locks in place.

To remove a battery pack:

- 1 Slide the battery release latch to release the battery.
- 2 Pull the battery from the battery bay.

Charging the battery

To charge the battery, first make sure that it is correctly installed in the battery bay. Plug the AC adapter into the computer, and connect to a mains power outlet. You can continue to operate your computer on AC power while your battery is charging. However, charging the battery with the computer turned off results in a significantly faster charge time.



Note: You are advised to charge the battery before retiring for the day. Charging the battery overnight before traveling enables you to start the next day with a fully charged battery.

Checking the battery level

The Windows Power Meter indicates the current battery level. Rest the cursor over the battery/power icon on the taskbar to see the battery's present charge level.

Optimizing battery life

Optimizing battery life helps you get the most out of battery operation, prolonging the charge/recharge cycle and improving recharging efficiency. You are advised to follow the suggestions set out below:

- Purchase an extra battery pack.
- Use AC power whenever possible, reserving battery for on-the-go use.
- Eject a PC Card if it is not being used, as it will continue to draw power.
- Store the battery pack in a cool, dry place. The recommended temperature is 10°C to 30°C. Higher temperatures cause the

battery to self-discharge faster.

- Excessive recharging decreases the battery life.
- Look after your AC adapter and battery.

Battery-low warning

When using battery power pay attention to the Windows Power Meter.



Warning: Connect the AC adapter as soon as possible after the battery-low warning appears. Data will be lost if the battery to become fully depleted and the computer shuts down.

When the battery-low warning appears, the recommended course of action depends on your situation:

Situation	Recommended Action
The AC adapter and a power outlet are available.	<ol style="list-style-type: none"> 1. Plug the AC adapter into the computer, and then connect to the mains power supply. 2. Save all necessary files. 3. Resume work. <p>Turn off the computer if you want to recharge the battery rapidly.</p>
An extra fully charged battery pack is available.	<ol style="list-style-type: none"> 1. Save all necessary files. 2. Close all applications. 3. Shut down the operating system to turn off the computer. 4. Replace the battery pack. 5. Turn on the computer and resume work.
The AC adapter or a power outlet is unavailable. You have no spare battery pack.	<ol style="list-style-type: none"> 1. Save all necessary files. 2. Close all applications. 3. Shut down the operating system to turn off the computer.

Power management

Your computer features a built-in power management unit that constantly monitors system activity. System activity refers to any activity involving one or more of the following devices: keyboard, touchpad/mouse, hard disk drive, optical drive, peripherals connected to the computer, and video memory. If no activity is detected for a period of time (the settings are controlled in Windows Power Management), the computer turns off some, or all, of these devices in order to conserve power.

Your computer employs a power management scheme that supports Advanced Configuration and Power Interface (ACPI), enabling maximum power conservation without compromising system performance. ACPI allows Windows to control the amount of power given to each device attached to the computer. In this way, Windows handles all power-saving chores for your computer. Refer to Windows Help and Support for more information.

Peripherals and **options**

Your TravelMate computer offers good expansion capabilities.

This chapter provides information on connecting peripherals to expand your system. It also describes how to upgrade key components to enhance system performance and keep your computer in step with the latest technology.

You are advised to consult your dealer for information on peripherals. In addition, make sure that you read the manuals and other documentation provided with new hardware.

External display devices

You can connect an external (VGA) monitor or projector to your computer's external display port.

Use the **Fn + F5** hot key to toggle the display setting between the computer's LCD panel and the external display device. See "Hot keys" on page 16 for more information.

External input devices

You can connect a variety of input devices to your computer's USB ports, providing increased functionality and greater ease-of-use. In addition, the USB ports can be used to connect many other peripheral devices, such as digital cameras, printers and scanners. See "Expansion devices" on page 44 for more information on connecting PC Card devices.

External keyboard

Your computer features a full-size keyboard. However, if you prefer, you can connect an external keyboard to one of your computer's USB ports. This enables you to enjoy the comfort and added features of a full-size desktop system keyboard when inputting typed data on your notebook computer.

External keypad

Your computer features an embedded keypad that, when combined with the Num Lock feature, enables you to easily input typed numeric data. Alternatively, you can connect a 17-key numeric keypad to one of your computer's USB ports. This enables you to enjoy the benefits of a numeric keypad without interfering with your use of the computer's keyboard for typing text.

External pointing device

Your computer features a sensitive touchpad pointing device with two click buttons and a scroll key. However, if you prefer to use a conventional mouse or other pointing device, you can connect it to one of your computer's USB ports.

USB devices

Your computer features four Universal Serial Bus (USB) 2.0 ports for connecting a range of USB peripherals. See “External input devices” on page 41, and “Printer” on page 43 for information on connecting a USB keyboard, keypad, mouse or printer. Other common USB devices include digital cameras, scanners, and external storage devices.

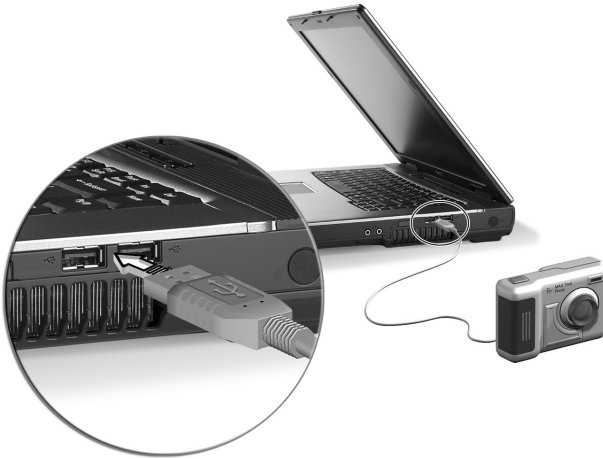

USB is plug and play, which means that you can connect and start using a USB device without having to restart your computer. You can also disconnect the device at any time.

A further advantage of USB is the ability to use USB hubs. This means that several devices can share a USB port simultaneously.

Printer

Your computer supports USB printers.

Refer to the printer's manual for information on:

- Setting up the hardware
- Installing the necessary drivers in Windows
- Operating instructions

To use a USB printer, simply connect the device to one of your computer's USB ports, and then wait for Windows to find the new hardware.

Audio devices

Your computer offers built-in stereo speakers. See the section entitled "Audio" on page 28 for more information on these features. However, in addition to the integrated devices, the two audio ports on the right side of the unit enable you to connect external audio input and output devices.

You can plug an external microphone into your computer's microphone-in jack. This offers the convenience of greater freedom of movement, as well as improved audio input quality.

Connect headphones to the headphone jack for private listening and improved audio output quality.

Expansion devices

PC Card

Your computer features one PC Card slot that support one standard Type II CardBus (PCMCIA). This greatly increases your computer's usability and expandability. A variety of PC Cards are available, such as flash memory, SRAM, fax/data modem, LAN, and SCSI Cards. Consult your dealer for information on PC Card options for your computer.



Note: Refer to your card's manual for details on how to install and use the card.

To insert a PC Card:

- 1 Align the card with your computer's PC Card slot. Make sure that the edge with the connectors is facing the slot, and that the card is the right way up. Many cards are marked with an arrow to help you insert them correctly.
- 2 Slide the card into the slot, and push gently until the card connects.
- 3 If necessary, connect the card's cable to the jack on the outer edge of the card.
- 4 Windows will automatically detect the card's presence.



To remove a PC Card:

- 1 Close the application that is using the PC Card.
- 2 Double click on the PC Card icon on the taskbar, and then select the option to safely remove the card. Wait for the message telling you that it is now safe to remove the card.
- 3 Press the PC Card eject button to partially eject the card (1).
- 4 Pull the card from the slot (2).

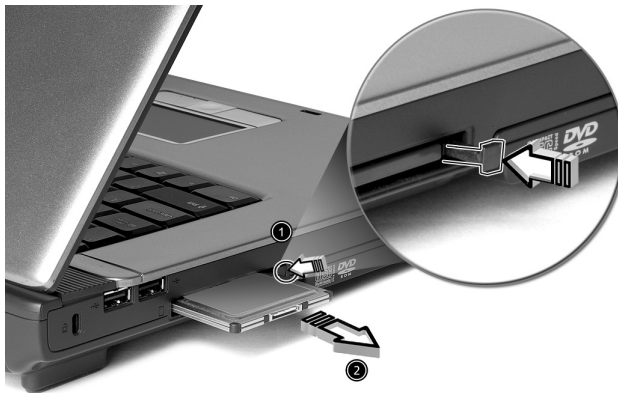

Miscellaneous options

Battery pack

It is a good idea to have a spare battery, especially when you travel with your computer. This greatly increases your productive range when you are on the move.

AC adapter

Having a spare AC adapter allows you to keep one in two different places. For example, you could have one AC adapter at home and another at work. This means that you don't have to carry an AC adapter when traveling between your two base locations.

Key component upgrades

Your computer is designed to deliver solid performance. However, in time, you might find that your applications demand even more computing power. For this reason, you are able to upgrade key components.



.....

Note: Contact your authorized dealer if you decide to perform a key component upgrade.

Memory upgrade

Memory is expandable to 2GB, employing 256/512/1024 MB dual industry standard small outline Dual Inline Memory Modules (soDIMM). The computer supports Double Data Rate (DDR) SDRAM.

Your computer has two memory slots. Upgrade memory by inserting a higher capacity DIMM into one or both of these slots.

Installing memory:

- 1 Turn off the computer. Make sure that the AC adapter is disconnected, and then remove the battery pack.
- 2 Turn the computer over to access the memory compartment on the bottom of the unit. Remove all screws (1) from the memory compartment door, and then lift the door off (2).



- 3 Insert the memory module diagonally in the slot (1), and then press down gently until it clicks in place (2).

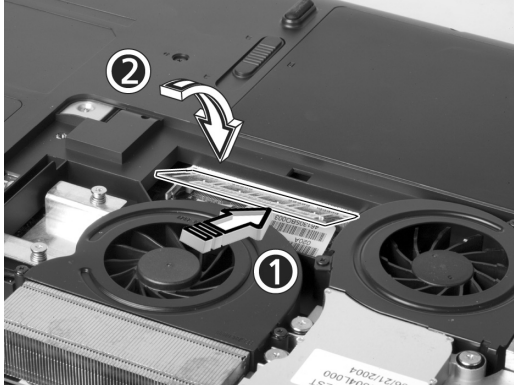

- 4 Replace the memory compartment door, and fasten the screw.

The computer automatically detects the new module and reconfigures the memory.

Hard disk upgrade

It is possible to replace your hard disk with a higher capacity drive when you need more storage space. Your computer uses a 9.5mm 2.5-inch Enhanced-IDE hard disk. Consult your dealer if you need to perform a hard disk upgrade.

Moving with your computer

Your TravelMate computer is ideal for taking with you when you move around.

This chapter provides tips on things to consider when traveling with your computer.

Disconnecting from the desktop

Before moving with your computer, you must turn it off and disconnect all peripherals:

- 1 Save your work and close all applications.
- 2 Shut down Windows to turn off your computer.
- 3 Unplug the AC adapter from the mains outlet, and then disconnect it from the computer.
- 4 Disconnect any external devices, such as a keyboard, mouse, or printer, that are attached to your computer.
- 5 If you are using a security lock cable, disconnect the lock from the computer.
- 6 Pack your computer in a strong, waterproof bag or case.

Moving around

Sometimes you might need to move your computer a short distance. For example, you might need to move from your office desk to a meeting room. In these situations, you don't have to shut down the operating system.

Preparing the computer

First, disconnect any peripherals that you don't want to take with you. Next close the lid, placing your computer in Standby mode. You can now safely carry it around the building with you.

When you are ready to use your computer again, open the lid and then press the power button to bring it out of Standby mode.

What to bring to short meetings

If your battery is fully charged, you probably won't need to take anything else with you to the meeting.

What to bring to long meetings

For longer meetings, take along the AC adapter. You can use mains power throughout the meeting, or you can run down your battery first, and then connect the AC adapter after receiving the battery-low warning.

If the meeting room does not have an available power outlet, reduce your computer's power consumption by putting it in Standby mode during long periods of inactivity. It is advisable to take along a spare battery if you have one.

Taking the computer home

When you move between your office and home you will need to prepare your computer for the short trip.

Preparing the computer

After disconnecting your computer from the desktop, prepare the unit as follows:

- 1 Remove all media from the drives. Loaded media can damage the drive heads during transit.
- 2 Pack the computer in a protective case that is padded to guard against knocks. Make sure that the unit cannot slide around inside the case.



.....

Caution: Avoid packing items next to the top of the computer, as this could result in damage to the screen.

What to bring with you

If you don't have spare items at home, it is advisable to take along the AC adapter and this User's Guide.

Special considerations

To protect your computer in transit, it is advisable to pay attention to the following:

- Minimize the effect of temperature changes. Keep your computer with you instead of placing it in storage holds.
- Avoid leaving your computer in a hot car.
- Changes in temperature and humidity can cause condensation to form within your computer. Before turning the computer on, allow it to return to room temperature, and then check the screen for signs of condensation. If the temperature change is greater than 10°C (18°F), allow the computer to come to room temperature slowly by placing it in a room with a temperature between the outside and room temperatures.

Setting up a home office

If you frequently work on your computer at home, as well as at work, it may be worthwhile purchasing a second AC adapter. This will allow you to travel lighter, as you can keep an AC adapter in each location.

You might also find it worthwhile keeping a second set of peripherals at home, such as a keyboard, keypad, mouse and printer.

Traveling with the computer

Sometimes you might need to make longer trips with your computer.

Preparing the computer

Prepare the computer as you would for moving between your office and home. It is advisable to make sure that the battery is fully charged. If you are traveling by air, you might be required to turn on the computer during security checks.

What to take with you

It is advisable to take the following items with you:

- AC adapter.
- Spare, fully charged battery packs.
- Additional printer driver files (if you plan to use another printer).
- Phone and network cables (if you plan to use the computer's modem and network connections).

Special considerations

In addition to the considerations for taking your computer home, keep the following in mind:

- Always take your computer as carry-on luggage.
- If possible, have your computer manually inspected at security checks. Although the computer can pass safely through security X-ray machines, you should never expose it to a metal detector.

Traveling internationally with your computer

Occasionally you might need to travel between countries with your computer.

Preparing the computer

Prepare the computer as you would for normal travel. Remember to take special precautions for air travel.

What to take with you

It is advisable to take the following items with you:

- AC adapter.
- Power cords that are appropriate for the countries you plan to visit.
- Spare, fully charged battery packs.
- Additional printer driver files (if you plan to use another printer).
- Phone and network cables (if you plan to use the computer's modem and network connections). Check that your modem is suitable for the telephone system in the countries you plan to visit. You might have to use a PC Card modem in some locations.

Special considerations

In addition to the considerations for normal travel with your computer, keep the following in mind when traveling internationally:

- Check that your power cord is suitable for the local power supply. If necessary, purchase a power cord that meets local requirements. Avoid using converter kits.
- If you plan to connect over a phone line, check that the computer's modem and your phone cord are suitable for the local phone system. If necessary, purchase a PC Card modem that meets local requirements.

Software

Your TravelMate computer includes system utilities.

This chapter provides information on the important software that comes with your computer.

System software

Your computer comes preloaded with the following software:

- Microsoft® Windows® operating system
- Hardware BIOS Setup Utility
- System utilities, drivers and application software



.....

Note: To run software applications in Windows, first click on the Start button. Next, select the appropriate folder, and then click on the application icon. To learn about the software and utility, make use of the online help provided by the software.

Using system utilities

Acer eManager

Acer eManager is an innovative software designed for frequently used functions. At the press of the Acer Empowering Key, the Acer eManager user interface appears, featuring two main settings -- Acer eSetting and Acer ePresentation (selected models).



To set the Acer Empowering Key, See "Launch keys" on page 21.

Launch Manager

The Acer Launch Manager allows you to set the programmable launch keys, including the default mail and Web browser keys, as well as the Empowering and P keys. The Wireless and Bluetooth keys cannot be set by users. See “Launch keys” on page 21 for more information.

You can access the Launch Manager by clicking on **Start, All Programs,** and then **Launch Manager** to start the application.

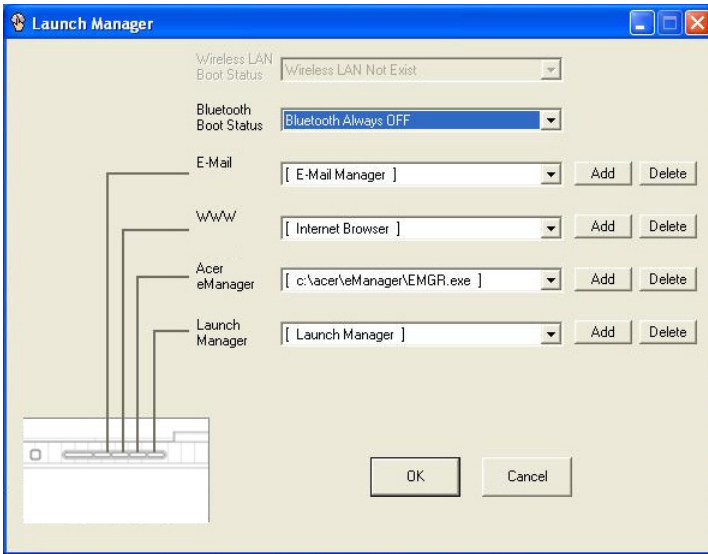

BIOS Utility

The BIOS Utility is a hardware configuration program built into your computer's Basic Input/Output System (BIOS).

Your computer is already properly configured and optimized, and you do not need to run this utility. However, if you encounter configuration problems, you may need to run it.

To activate the BIOS Utility, press **F2** during the Power-On Self Test (POST) while the Acer logo is being displayed.

Acer Disc to Disc Recovery



.....
Note: This feature is only available on certain models.

Multilingual operating system installation

Follow the instructions to choose the operating system and language you use when you first power-on the system.

- 1 Turn on the system.
- 2 Acer multilingual operating system selection menu will pop-up automatically.
- 3 Use the arrow keys to scroll to the language version you want. Press Enter to confirm your selection.
- 4 The operating system and language you choose now will be the only option for future recovery operations.
- 5 The system will install the operating system and language you choose.

Restore without a Recovery CD

This recovery process helps you restore the C: drive with the original software content that is installed when you purchase your notebook. Follow the steps below to rebuild your C: drive. (Your C: drive will be reformatted and all data will be erased.) It is important to back up all data files before you use this option.

Before performing a restore operation, please check the BIOS settings.

- a Check to see if "Acer disc-to-disc" function is enabled or not.
- b Make sure the [Acer D2D Recovery] setting in [Main] is [Enabled].
- c Exit the BIOS Setup Utility and save changes. The system will reboot.



.....
Note: To activate BIOS Setup Utility, press <F2> during POST.

- 1 Restart the system.
- 2 The instruction "Press <F2> to Enter BIOS" is shown at the bottom of the screen, during POST.
- 3 Press <Alt> + <F10> at the same time to enter the recovery process.
- 4 The message "The system has password protection. Please enter 000000:" is displayed.
- 5 Enter six 0s and continue.
- 6 "Acer Self-Configuration Preload" window appears.
- 7 Use the arrow keys to scroll through the items (operating system versions) and press "Enter" to select.

Setup password and exit

Press "**F3**" to setup password or press "**F5**" to exit the system recovery process when "Acer Self-Configuration Preload" window appears.

If "**F3**" is pressed, the next screen shows "Please enter new password:" enter one to eight alphanumeric characters. You will be asked to reenter your password for confirmation before continuing.

The screen will display "Password has been created. Press any key to reboot...", hit any key to reboot your system.

If "**F5**" is pressed, the recovery process will be terminated and the system will reboot and start normally.



.....

Important: This feature occupies 2 GB in a hidden partition on your hard drive.

Troubleshooting

This chapter instructs you on how to deal with common system problems. Please read it before calling a technician.

Solutions to more serious problems may require opening the computer. Do not attempt to open and service the computer by yourself. Contact your dealer or an authorized service center for assistance.

Frequently asked questions

This section suggests solutions to commonly encountered problems.

I press the power button, but my computer does not start or boot-up.

Look at the Power status indicator:

- If it is not lit, no power is being delivered to the computer. Check the following:
 - If you are running on battery power, the battery may be low and unable to power the computer. Connect the AC adapter to recharge the battery pack.
 - If you are running on mains power, make sure that the AC adapter is properly plugged in to the computer and to the power outlet.

Nothing appears on the screen.

The computer's power management system automatically blanks the screen to save power. Press any key to turn the display back on.

If pressing a key does not turn the display back on, check the following:

- The brightness level might be too low. Press **Fn + →** hot key to increase the screen brightness level.
- The display device might be set to an external monitor. Press the **Fn + F5** hot key to toggle the display setting.
- The system may be in standby mode. Try pressing the power button to resume.

The image is not full-screen.

Make sure that the resolution is set to a resolution your system supports:

- Right click on your Windows desktop and select Properties to bring up the Display Properties dialog box. Alternatively, click on the Display icon in Control Panel.
- Click on the Settings tab to check the resolution setting. Resolutions lower than the specified resolution result in a display that is less than full-screen.

There is no audio coming from my computer.

Check the following:

- The volume may be muted. In Windows, look at the volume control icon on the taskbar. If it is crossed-out, click on the icon and deselect the Mute option.
- The volume level may be too low. In Windows, click on the volume control icon on the taskbar, and then use the slider control to increase the volume level.
- If headphones are connected to the headphone jack on the computer, your computer's built-in speakers will be turned off.

My external microphone does not work.

Check the following:

- Make sure that the external microphone is properly plugged into the microphone-in jack on the computer.
- Make sure that the volume is not muted or set too low.

I can't eject the optical drive tray with my computer turned off.

The computer needs to be turned on for the optical drive eject button to function. If you need to eject the optical drive tray when the computer is turned off, push a straightened paper clip into the optical drive emergency eject hole. See "Emergency ejection of the optical drive tray" on page 24 for more information.

The keyboard does not respond.

Try attaching an external USB keyboard to one of your computer's USB ports. If it works, the internal keyboard might have become disconnected. Contact your dealer or an authorized service center.

The optical drive cannot read a disc.

Check the following:

- Make sure that the disc is supported by the drive. If your computer has a CD-ROM drive, it can read CDs but cannot read DVDs. If your computer has a DVD drive, it can read both CDs and DVDs.
- When placing a disc in the drive tray, make sure that it is secure on the spindle of the drive tray.
- Make sure that the disc is free from scratches or smudges. If the disc is dirty, clean it using a disc cleaning kit.

- If the disc is OK, the drive head might be dirty. Clean it using a drive head cleaning kit.

The printer does not work.

Check the following:

- Make sure that the printer is connected to a power outlet and it is turned on.
- Check that the cable is properly connected to the appropriate ports on both the computer and the printer.
- If you are using a printer connected to your computer's parallel port, restart the computer. Windows needs to find the new hardware and install the necessary drivers.

I want to set up my location to use the internal modem.

Follow these steps:

- Click on **Start**, and then click on **Control Panel**.
- Double-click on **Phone and Modem Options**.
- In the **Dialing Rules** tab, begin setting up your location.

Refer to Windows Help and Support for more information.

When the battery is 95-99% full, it won't charge to 100% capacity.

To preserve the life of the battery, the system only lets you charge the battery when its capacity falls below 95%. It is recommended that you run down the battery, and then fully recharge it.

Requesting service

International Traveler's Warranty (ITW)

Your computer is backed by an International Traveler's Warranty (ITW) that gives you security and peace of mind when traveling. Our worldwide network of service centers are there to give you a helping hand.

An ITW passport comes with your computer. This passport contains all you need to know about the ITW program. A list of available, authorized service centers is in this handy booklet. Read this passport thoroughly.

Always have your ITW passport on hand, especially when you travel to receive the benefits from our support centers. Place your proof-of-purchase in the flap located inside the front cover of the ITW passport.

If the country you are traveling in does not have an Acer-authorized ITW service site, you can still get in contact with our offices worldwide.

Please consult www.acersupport.com.

Before you call

Please have the following information available when you call Acer for online service, and please be at your computer when you call. With your support, we can reduce the amount of time a call takes and help solve your problems efficiently.

If there are error messages or beeps reported by your computer, write them down as they appear on the screen (or the number and sequence in the case of beeps).

You are required to provide the following information:

Name: _____

Address: _____

Telephone number: _____

Machine and model type: _____

Serial number: _____

Date of purchase: _____

Appendix A

Specifications

This appendix lists the general specifications of your computer.

Microprocessor

- Intel® Pentium® 4 processors 2.8/3.0/3.2/3.4/3.6 GHz or or Intel® Celeron® processors 2.6 GHz and above

Memory

- 256/512 MB of DDR333 SDRAM standard, upgradeable to 2048 MB with dual soDIMM modules
- 512 KB flash ROM BIOS

Data storage

- One 30 GB and above E-IDE hard disk (2.5", 9.5mm, UltraDMA-100)
- One internal optical drive

Display and video

- The TFT LCD panel providing a large viewing area for maximum efficiency and ease-of-use:
 - 15.0" XGA (1024x768) resolution
 - 15.4" WXGA (1280x800) resolution
- Simultaneous LCD and CRT display support
- DualView™ support
- "Automatic LCD dim" feature, automatically selecting the best setting for the display in order to conserve power

Connectivity

- Integrated 10/100 Mbps Fast Ethernet connection
- Built-in 56Kbps fax/data modem
- IEEE 802.11b/g Wireless LAN (manufacturing option)
- Bluetooth® (manufacturing option)

Audio

- Two built-in stereo speakers
- MS DirectSound compatible
- Audio ports for microphone-in and headphones

Keyboard and pointing device

- 84/85/88-key Windows keyboard
- Ergonomically-centered touchpad pointing device

I/O ports

- One Type II PC CardBus (PCMCIA) slot
- One RJ-11 modem jack (V.92, 56Kbps modem)
- One RJ-45 network jack (Ethernet 10/100 Base-T)
- One DC-in jack
- One Infrared (FIR) port (manufacturing option)
- One external monitor port
- One microphone-in jack (3.5mm mini jack)
- One headphone jack (3.5mm mini jack)
- Four USB 2.0 ports

Weight and dimensions

- 15.0" display model:
 - 3.4 kg (7.50 lbs)
 - 365(W) x 288.5(D) x 45(max. H) mm

Environment

- Temperature:
 - Operating: 5°C ~ 35°C
 - Non-operating: -20°C ~ 65°C
- Humidity (non-condensing):
 - Operating: 20% ~ 80% RH
 - Non-operating: 20% ~ 80% RH

Operating system

- Microsoft® Windows® XP Home/Pro operating system
- ACPI 1.0b support
- DMI 2.0-compliant

Power

- 8-cell Li-ion battery pack
- 135W AC adapter 19V

Options

- 256MB/512MB/1G memory upgrade module
- Additional 135W AC adapter
 - Type No.:
 - HP-OW135F13 (Tech No.: 19Vdc 135W)
 - ADP-135DB (Tech No.: 19Vdc 135W)
 - PA-1131-08 (Tech No.: 19Vdc 135W)
- Additional Li-ion battery pack
 - Type No.:
 - BATELW80L8 (Tech No.: 14.8Vdc 4.3Ah)
 - BATELW80L8H (Tech No.: 14.8Vdc 4.0Ah)

Appendix B

Regulation & safety

This appendix lists the general notices for your computer.

Energy Star Guidelines Compliance

As an Energy Star Partner, Acer Inc. has determined that this product meets the Energy Star guidelines for energy efficiency.

FCC notice

This device has been tested and found to comply with the limits for a Class B digital device pursuant to Part 15 of the FCC Rules. These limits are designed to provide reasonable protection against harmful interference in a residential installation. This device generates, uses, and can radiate radio frequency energy and, if not installed and used in accordance with the instructions, may cause harmful interference to radio communications.

However, there is no guarantee that interference will not occur in a particular installation. If this device does cause harmful interference to radio or television reception, which can be determined by turning the device off and on, the user is encouraged to try to correct the interference by one or more of the following measures:

- Reorient or relocate the receiving antenna.
- Increase the separation between the device and receiver.
- Connect the device into an outlet on a circuit different from that to which the receiver is connected.
- Consult the dealer or an experienced radio/television technician for help.

Notice: Shielded cables

All connections to other computing devices must be made using shielded cables to maintain compliance with FCC regulations.

Notice: Peripheral devices

Only peripherals (input/output devices, terminals, printers, etc.) certified to comply with the Class B limits may be attached to this equipment. Operation with non-certified peripherals is likely to result in interference to radio and TV reception.

Caution

Changes or modifications not expressly approved by the manufacturer could void the user's authority, which is granted by the Federal Communications Commission, to operate this computer.

Operation conditions

This device complies with Part 15 of the FCC Rules. Operation is subject to the following two conditions: (1) this device may not cause harmful interference, and (2) this device must accept any interference received, including interference that may cause undesired operation.

Notice: Canadian users

This Class B digital apparatus complies with Canadian ICES-003.

Remarque à l'intention des utilisateurs canadiens

Cet appareil numérique de la classe B est conforme à la norme NMB-003 du Canada.

Declaration of Conformity for EU countries

Hereby, Acer, declares that this TravelMate, Aspire series is in compliance with the essential requirements and other relevant provisions of Directive 1999/5/EC. (Please visit www.acer.com/about/certificates/nb for complete documents.)

Compliant with Russia regulatory certification



ME61

Modem notices

Notice for USA

This equipment complies with Part 68 of the FCC rules. Located on the bottom side of the modem is a label that contains, among other information, the FCC Registration Number and Ringer Equivalence

Number (REN) for this equipment. Upon request, you must provide this information to your telephone company.

If your telephone equipment causes harm to the telephone network, the telephone company may discontinue your service temporarily. If possible, they will notify you in advance. But, if advance notice is not practical, you will be notified as soon as possible. You will also be informed of your right to file a complaint with the FCC.

Your telephone company may make changes in its facilities, equipment, operations, or procedures that could affect the proper functioning of your equipment. If they do, you will be notified in advance to give you an opportunity to maintain uninterrupted telephone service.

If this equipment should fail to operate properly, disconnect the equipment from the phone line to determine if it is causing the problem. If the problem is with the equipment, discontinue use and contact your dealer or vendor.



.....
Caution: To reduce the risk of fire, use only No. 26 AWG or larger UL Listed or CSA Certified Telecommunication Line Cord.

TBR 21

This equipment has been approved [Council Decision 98/482/EC - "TBR 21"] for single terminal connection to the Public Switched Telephone Network (PSTN). However, due to differences between the individual PSTNs provided in different countries, the approval does not, of itself, give an unconditional assurance of successful operation on every PSTN termination point. In the event of problems, you should contact your equipment supplier in the first instance.

List of Applicable Countries

EU member states as of April 2003 are: Belgium, Denmark, Germany, Greece, Spain, France, Ireland, Italy, Luxembourg, the Netherlands, Austria, Portugal, Finland, Sweden, and the United Kingdom. Usage allowed in the countries of European Union, as well as Norway, Switzerland, Iceland and Liechtenstein. This device must be used in strict accordance with the regulations and constraints in the country of use. For further information, please contact local office in the country of use.

Notice for Australia

For safety reasons, only connect headsets with a telecommunications compliance label. This includes customer equipment previously labelled permitted or certified.

Notice for New Zealand

For Modem with approval number PTC 211/03/008

- 1 The grant of a Telepermit for any item of terminal equipment indicates only that Telecom has accepted that the item complies with minimum conditions for connection to its network. It indicates no endorsement of the product by Telecom, nor does it provide any sort of warranty. Above all, it provides no assurance that any item will work correctly in all respects with another item of Telepermitted equipment of a different make or model, nor does it imply that any product is compatible with all of Telecom's network services.
- 2 This equipment is not capable, under all operating conditions, of correct operation at the higher speeds for which it is designed. Telecom will accept no responsibility should difficulties arise in such circumstances.
- 3 Some parameters required for compliance with Telecom's Telepermit requirements are dependent on the equipment (PC) associated with this device. The associated equipment shall be set to operate within the following limits for compliance with Telecom's Specifications:
 - a There shall be no more than 10 call attempts to the same number within any 30 minute period for any single manual call initiation, and
 - b The equipment shall go on-hook for a period of not less than 30 seconds between the end of one attempt and the beginning of the next call attempt.
- 4 Some parameters required for compliance with Telecom's Telepermit requirements are dependent on the equipment (PC) associated with this device. In order to operate within the limits for compliance with Telecom's specifications, the associated equipment shall be set to ensure that automatic calls to different numbers are spaced such that there is not less than 5 seconds between the end of one call attempt and the beginning of another.

- 5 This equipment shall not be set up to make automatic calls to Telecom's 111 Emergency Service.

Important safety instructions

Read these instructions carefully. Save them for future reference.

- 1 Follow all warnings and instructions marked on the product.
- 2 Unplug this product from the wall outlet before cleaning. Do not use liquid cleaners or aerosol cleaners. Use a damp cloth for cleaning.
- 3 Do not use this product near water.
- 4 Do not place this product on an unstable cart, stand, or table. The product may fall, causing serious damage to the product.
- 5 Slots and openings are provided for ventilation; to ensure reliable operation of the product and to protect it from overheating. These openings must not be blocked or covered. The openings should never be blocked by placing the product on a bed, sofa, rug, or other similar surface. This product should never be placed near or over a radiator or heat register, or in a built-in installation unless proper ventilation is provided.
- 6 This product should be operated from the type of power indicated on the marking label. If you are not sure of the type of power available, consult your dealer or local power company.
- 7 Do not allow anything to rest on the power cord. Do not locate this product where persons will walk on the cord.
- 8 If an extension cord is used with this product, make sure that the total ampere rating of the equipment plugged into the extension cord does not exceed the extension cord ampere rating. Also, make sure that the total rating of all products plugged into the wall outlet does not exceed the fuse rating.
- 9 Never push objects of any kind into this product through cabinet slots as they may touch dangerous voltage points or short out parts that could result in a fire or electric shock. Never spill liquid of any kind on the product.
- 10 Do not attempt to service this product yourself, as opening or removing covers may expose you to dangerous voltage points or other risks. Refer all servicing to qualified service personnel.
- 11 Unplug this product from the wall outlet and refer servicing to qualified service personnel under the following conditions:
 - a When the power cord or plug is damaged or frayed.

- b If liquid has been spilled into the product.
 - c If the product has been exposed to rain or water.
 - d If the product does not operate normally when the operating instructions are followed. Adjust only those controls that are covered by the operating instructions since improper adjustment of other controls may result in damage and will often require extensive work by a qualified technician to restore the product to normal condition.
 - e If the product has been dropped or the case has been damaged.
 - f If the product exhibits a distinct change in performance, indicating a need for service.
- 12 The TravelMate, Aspire series uses the lithium battery. Replace the battery with the same type as the product's battery we recommend in the product specification list. Use of another battery may present a risk of fire or explosion.
 - 13 **Warning!** Batteries may explode if not handled properly. Do not disassemble or dispose of them in fire. Keep them away from children and dispose of used batteries promptly.
 - 14 Use only the proper type of power supply cord set (provided in your accessories box) for this unit. It should be a detachable type: UL listed/CSA certified, type SPT-2, rated 7A 125V minimum, VDE approved or its equivalent. Maximum length is 15 feet (4.6 meters).
 - 15 Always disconnect all telephone lines from the wall outlet before serving or disassembling this equipment.
 - 16 Avoid using a telephone (other than a cordless type) during an electrical storm. There may be a remote risk of electric shock from lightning.

Laser compliance statement

The CD or DVD drive used with this computer is a laser product. The CD or DVD drive's classification label (shown below) is located on the drive.

CLASS 1 LASER PRODUCT

CAUTION: INVISIBLE LASER RADIATION WHEN OPEN. AVOID EXPOSURE TO BEAM.

APPAREIL A LASER DE CLASSE 1 PRODUIT
LASERATTENTION: RADIATION DU FAISCEAU LASER INVISIBLE EN CAS
D'OUVERTURE. EVITER TOUTE EXPOSITION AUX RAYONS.

LUOKAN 1 LASERLAITE LASER KLASSE 1
VORSICHT: UNSICHTBARE LASERSTRAHLUNG, WENN ABDECKUNG
GEÖFFNET NICHT DEM STRAHL AUSSETZEN

PRODUCTO LÁSER DE LA CLASE I
ADVERTENCIA: RADIACIÓN LÁSER INVISIBLE AL SER ABIERTO. EVITE
EXPONERSE A LOS RAYOS.

ADVARSEL: LASERSTRÅLING VEDÅBNING SE IKKE IND I STRÅLEN.

VARO! LAVATTAESSA OLET ALTTINA LASERSÄTEILYLLE.
VARNING: LASERSTRÅLNING NÅR DENNA DEL ÅR ÖPPNAD ÅLÅ
TUIJOTA SÄTEESEENSTIRRA EJ IN I STRÅLEN

VARNING: LASERSTRÅLNING NAR DENNA DEL ÅR ÖPPNADSTIRRA EJ IN
I STRÅLEN

ADVARSEL: LASERSTRÅLING NAR DEKSEL ÅPNESSTIRR IKKE INN I
STRÅLEN

LCD pixel statement

The LCD unit is produced with high-precision manufacturing techniques. Nevertheless, some pixels may occasionally misfire or appear as black or red dots. This has no effect on the recorded image and does not constitute a malfunction.

Macrovision® copyright protection notice

This product incorporates copyright protection technology that is protected by method claims of certain U.S. patents and other intellectual property rights owned by Macrovision Corporation and other rights owners. Use of this copyright protection technology must be authorized by Macrovision Corporation, and is intended for home and other limited viewing uses only unless otherwise authorized by Macrovision Corporation. Reverse engineering or disassembly is prohibited.

Apparatus Claims of U.S. Patent Nos. 4,631,603, 4,577,216, 4,819,098, 4,907,093, and 6,516,132 licensed for limited viewing uses only.

Radio Device Regulatory Notice

Note: Below regulatory information is for models with wireless LAN and/or Bluetooth™ only.

General

This product complies with the radio frequency and safety standards of any country or region in which it has been approved for wireless use. Depending on configurations, this product may or may not contain wireless radio devices (such as wireless LAN and/or Bluetooth® modules). Below information is for products with such devices.

European Union (EU)

This device complies with the essential requirements of the European Council Directives listed below:

73/23/EEC Low Voltage Directive



- EN 60950

89/336/EEC Electromagnetic Compatibility (EMC) Directive

- EN 55022
- EN 55024
- EN 61000-3-2/-3

99/5/EC Radio & Telecommunications Terminal Equipment (R&TTE) Directive

- Art.3.1a) EN 60950
- Art.3.1b) EN 301 489 -1/-17
- Art.3.2) EN 300 328-2
- Art.3.2) EN 301 893 *applied to 5 GHz only

   (for 5 GHz device)

List of Applicable Countries

EU member states as of May 2004 are: Belgium, Denmark, Germany, Greece, Spain, France, Ireland, Italy, Luxembourg, the Netherlands, Austria, Portugal, Finland, Sweden, United Kingdom Estonia, Latvia, Lithuania, Poland, Hungary, Czech Republic, Slovak Republic, Slovenia,

Cyprus and Malta. Usage allowed in the countries of European Union, as well as Norway, Switzerland, Iceland and Liechtenstein. This device must be used in strict accordance with the regulations and constraints in the country of use. For further information, please contact local office in the country of use.

The FCC RF safety requirement

The radiated output power of Wireless LAN Mini-PCI Card and Bluetooth card is far below the FCC radio frequency exposure limits. Nevertheless, the Aspire series shall be used in such a manner that the potential for human contact during normal operation is minimized as follows:

- 1 Users are requested to follow the RF safety instructions on wireless option devices that are included in the user's manual of each RF option device.



Caution: To comply with FCC RF exposure compliance requirements, a separation distance of at least 20 cm (8 inches) must be maintained between the antenna for the integrated Wireless LAN Mini-PCI Card built in to the screen section and all persons.

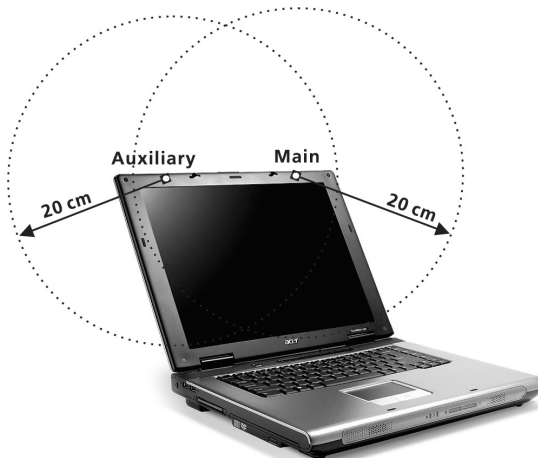



Note: Acer Wireless Mini PCI Adapter implements transmission diversity function. The function does not emit radio frequencies simultaneously from both antennas. One of the antennas is selected automatically or manually (by users) to have good quality of radiocommunication.

- 2 This device is restricted to indoor use due to its operation in the 5.15 to 5.25 GHz frequency range. FCC requires this product to be used indoors for the frequency range 5.15 to 5.25 GHz to reduce the potential for harmful interference to co-channel Mobile Satellite systems.
- 3 High power radar are allocated as primary users of the 5.25 to 5.35 GHz and 5.65 to 5.85 GHz bands. These radar stations can cause interference with and/or damage this device.
- 4 An improper installation or unauthorized use may cause harmful interference to radio communications. Also any tampering of the internal antenna will void the FCC certification and your warranty.

Canada - Low power license-exempt radiocommunication devices (RSS-210)

- a Common information
Operation is subject to the following two conditions:
 1. This device may not cause interference, and
 2. this device must accept any interference, including interference that may cause undesired operation of the device.
 - b Operation in 2.4 GHz band
To prevent radio interference to the licensed service, this device is intended to be operated indoors and installed outdoors is subject to licensing.
 - c Operation in 5 GHz band
- The device for the band 5150-5250 MHz is only for indoor usage to reduce potential for harmful interference to co-channel Mobile Satellite systems.
 - High power radars are allocated as primary users (meaning they have priority) of 5250-5350 MHz and 5650-5850 MHz and these radars could cause interference and/or damage to LELAN (Licence-Exempt Local Area Network) devices.

Exposure of humans to RF fields (RSS-102)

The TravelMate, Aspire series employs low gain integral antennas that do not emit RF field in excess of Health Canada limits for the general population; consult Safety Code 6, obtainable from Health Canada's Web site at www.hc-sc.gc.ca/rpb.

**Federal Communications Commission
Declaration of Conformity**

This device complies with Part 15 of the FCC Rules. Operation is subject to the following two conditions: (1) this device may not cause harmful interference, and (2) this device must accept any interference received, including interference that may cause undesired operation.

The following local Manufacturer/Importer is responsible for this declaration:

Product:	Notebook Personal Computer
Model Number:	LW80
Machine Type:	TravelMate 2200/2700
SKU Number:	TravelMate 220xxx/270xxx (*x* = 0~9, a~z, or A~Z)
Name of Responsible Party:	Acer America Corporation
Address of Responsible Party:	2641 Orchard Parkway, San Jose CA 95134, U. S. A.
Contact Person:	Mr. Young Kim
Phone No.:	408-922-2909
Fax No.:	408-922-2606



Acer Incorporated
8F, 88, Sec. 1, Hsin Tai Wu Rd., Hsichih
Taipei Hsien 221, Taiwan, R.O.C.

Tel : 886-2-2696-1234
Fax : 886-2-2696-3335
www.acer.com



Declaration of Conformity for CE marking

We,

Acer Inc.
8F, 88, Sec. 1, Hsin Tai Wu Rd., Hsichih,
Taipei Hsien 221, Taiwan, R. O. C.

Contact Person: Mr. Easy Lai
Tel: 886-2-8691-3089 Fax: 886-2-8691-3000
E-mail: easy_lai@acer.com.tw

Hereby declare that:

Product:	Notebook PC
Trade Name:	Acer
Model Number:	LW80
Machine Type:	TravelMate 2200/2700
SKU Number:	TravelMate 220xxx/270xxx (*x* = 0~9, a~z, or A~Z)

Is in compliance with the essential requirements and other relevant provisions of the following EC directives.

Reference No.	Title
89/336/EEC	Electromagnetic Compatibility (EMC directive)
73/23/EEC	Low Voltage Directive (LVD)
1999/5/EC	Radio & Telecommunications Terminal Equipment Directive (R&TTE)

The product specified above was tested conforming to the applicable Rules under the most accurate measurement standards possible, and that all the necessary steps have been taken and are in force to assure that production units of the same product will continue to comply with the requirements.

Easy Lai

Easy Lai/ Director
Qualification Center
Product Assurance, Acer Inc.

2004/7/19

Date

Index

A

- Acer 62
- audio 28
 - connecting externally 43
 - controlling volume 28
 - troubleshooting 68

B

- battery pack
 - battery-low warning 36
 - caring for v
 - characteristics 33
 - charging 35
 - checking charge level 35
 - installing 34
 - low conditions 36
 - maximizing life 33
 - optimizing 35
 - removing 35
 - using the first time 33

BIOS utility 61

- brightness
 - hotkeys 17

C

- caps lock 13
 - on indicator 12

- care
 - battery pack v
 - computer iv

- CD
 - troubleshooting 68

- charging
 - checking level 35

- cleaning
 - computer v

- computer
 - bringing to meetings 52
 - caring for iv
 - cleaning v
 - disconnecting 51
 - features 10
 - keyboards 13
 - moving around 52
 - on indicator 12

- security 29
- setting up a home office 54
- taking home 53
- traveling internationally 55
- traveling on local trips 54
- turning off iii

- connections
 - audio 43
 - external display devices 41
 - external input devices 41
 - keyboard, external 41
 - keypad, external 41
 - mouse 41
 - printer 43
 - USB 42
- connectivity options 25
 - Ethernet 25

D

- display
 - hotkeys 17
 - troubleshooting 67
- DVD
 - troubleshooting 68

E

- Ethernet connection 25
- Euro 17, 18

F

- FAQ. See frequently-asked questions
- frequently-asked questions 67
- front view 3

G

- guide iii

H

- hard disk 23
 - upgrading 47
- help iii
- Hibernation mode
 - hotkey 16
- hotkeys 16

I

- infrared 27
- ITW. See warranty

K

- keyboard 13
 - connecting externally 41
 - embedded numeric keypad 14
 - hotkeys 16
 - lock keys 13
 - troubleshooting 68
 - Windows keys 15

- keypad
 - connecting externally 41

L

- left view 5

M

- media access
 - on indicator 12
- memory
 - installing 46–47
 - upgrading 46
- microphone
 - troubleshooting 68
- modem
 - setting location 69
- mouse
 - connecting externally 41

N

- Notebook Manager
 - hotkey 16
- notice
 - DVD copyright protection 85
- num lock 13
 - on indicator 12
- numeric keypad
 - embedded 14
 - num lock 14

O

- optical drive 23
- options
 - hard disk upgrade 47
 - memory upgrade 46
 - PC Cards 44
 - spare AC adapter 45
 - spare battery 45

P

- PC Card

- inserting 44
 - removing 45
- power management 37
- Power-On Self-Test (POST) 61
- printer
 - connecting 43
 - troubleshooting 69
- problems 67
 - audio 68
 - CD 68
 - display 67
 - DVD 68
 - keyboard 68
 - printer 69
 - startup 67

R

- rear view 8
- right view 7

S

- safety
 - CD or DVD 84
 - FCC notice 79
 - general instructions 83
 - modem notices 80
- scroll lock 13
- security
 - slot 29
- service
 - when to call v
- software
 - bundled 59
- speakers
 - hotkey 17
 - troubleshooting 68
- Standby mode
 - hotkey 16
- status indicators 12
- status LCD 12
- storage 23
 - hard disk 23
 - optical drive 23
- support
 - information 70

T

- touchpad 19
 - hotkey 17

- using 19– 20
- travel
 - international flights 55
 - local trips 54

U

USB

- connecting 42

V

volume

- adjusting 28

W

warranty

- International Traveler's Warrant-
ty 70

- Windows keys 15